



# DM Dura|Mate™ Family



## Environmentally-Sealed, Multi-Pin, Heavy-Duty, Plastic or Metal Circular Connectors

Amphenol Sine Systems' **DuraMate™ Family** of environmentally-sealed, multi-pin, heavy duty, plastic (AHDP) or metal (AHDM/AHDBM) circular connectors provide a circular bayonet locking system, or blind mate option, manufactured to withstand the challenges and complexities of harsh-environment, off-road applications. Our ISOBUS 91 Series products specifically meet ISO 11783 standards (for control and communications between tractors, implements and software) for agricultural applications. Available in the following variations: **DuraMate™ AHDP**, **DuraMate™ AHDP with PanelMate™**, **DuraMate™ AHDP with HYPERBUS™**, **DuraMate™ AHDP ISOBUS 91 Series**, **DuraMate™ AHDM** and **DuraMate™ AHDM/AHDBM ISOBUS 91 Series**.



### Key Features

- 3 key-way circular bayonet design or blind mate option ensures proper mating of connectors
- High density signal and mixed power insert configurations
- Operating temperature range: -55°C to +125°C
- High current configurations incorporating revolutionary RADSOK® contacts
- High strength impact resistant & lightweight thermoplastic, zinc-alloy or aluminum alloy metal housings
- Low insertion force stamped terminals offer improved manufacturing efficiencies
- Environmentally-sealed and engineered rapid and secure mating system achieves up to IP69K rating (in mated condition) from ingress of dust, water, mud and other contaminants and is vibration resistant
- Sealing features consisting of durable high temperature silicone provide barrier from lubricating oils, hydraulic fluids and fossil fuels
- Wire entry sealing available in three separate ranges for discrete wire applications
- Backshells maintain a compression-fit design to resist maximum pull-out forces and facilitate strain-relief for jacketed cable ranges
- Backshell Ring Adapters (BRA) allow for use with other compatible industry-standard snap-on backshells
- Smooth Ring Adapters (SRA) are designed for use without backshells for a smaller footprint
- Small Thread Adapters (STA) provide an enhanced "step down" threading for use with screw-on or clamshell backshells
- Wide Thread Adapters (WTA) provide an enhanced threading for use with our wide variety of screw-on or clamshell backshells
- Utilizes A Series™ standard contact system (Stamped & Formed or Machined)



For available DuraMate™ Series **Boots**, refer to our [A Series™ Boots Flyer](#).

For available DuraMate™ Series **Contacts and Tooling**, refer to individual part number datasheets found at [www.amphenol-sine.com](http://www.amphenol-sine.com) or our [A Series Contacts Flyer](#).

### IP Ratings

IP67 rated (Dust tight; 1M of Water for 30 Minutes, in mated condition)

IP68 rated (Dust tight; 1M of Water for 24 Hours, in mated condition)

IP69K rated (Dust tight; High-Pressure Waterproof, 4 Points (0°, 30°, 60°, 90°), in mated condition)



Standard products. Custom solutions  
Customer Service +1 800 394 7732

DuraMate™ AHDP/AHDM Series - Part Numbering Sequence

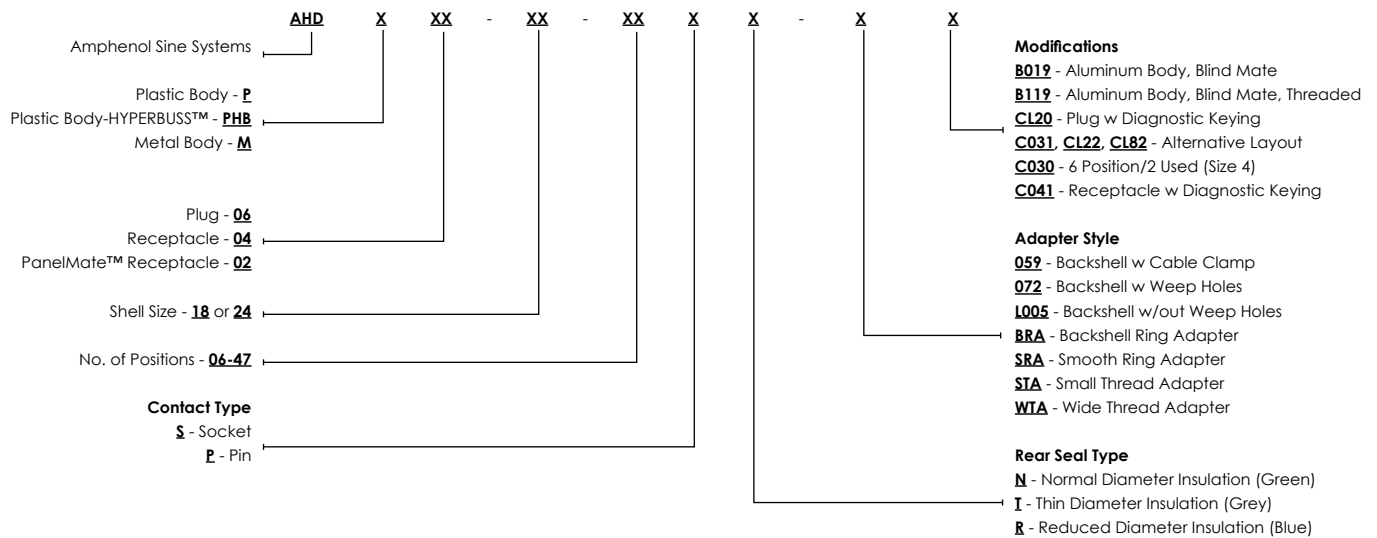

DuraMate™ AHDP and AHDM Series - Adapter & Modification Examples

	<p><b>AHDM08-24-31SR-B019</b> - Shell Size 24, 31 Pos, <b>Plug</b>, Socket, Size 16 Contact, 13A, 250V, DuraMate™ AHDM Series, <b>Aluminum Alloy, Blind Mate Coupling System</b>, Reduced Diameter Rear Seal (Red), Blue Retaining Ring, Keyed, Silver Body</p> <p><b>AHDM09-24-31PR-B019</b> - Shell Size 24, 31 Pos, <b>Recept</b>, Pin, Size 16 Contact, 13A, 250V, DuraMate™ AHDM Series, <b>Aluminum Alloy, Blind Mate Coupling System</b>, Reduced Diameter Rear Seal (Red), Blue Retaining Ring, Keyed, Silver Body</p>
	<p><b>AHDM08-24-31ST-B119</b> - Shell Size 24, 31 Pos, <b>Plug</b>, Socket, Size 16 Contact, 13A, 250V, DuraMate™ AHDM Series, <b>Aluminum Alloy, Blind Mate Coupling System</b>, Reduced Diameter Rear Seal (Red), <b>Integrated Wide Thread (Grey Retaining Ring)</b>, Keyed, Silver Body</p> <p><b>AHDM09-24-31PT-B119</b> - Shell Size 24, 31 Pos, <b>Recept</b>, Pin, Size 16 Contact, 13A, 250V, DuraMate™ AHDM Series, <b>Aluminum Alloy, Blind Mate Coupling System</b>, Thin Diameter Rear Seal (Red), <b>Integrated Wide Thread (Grey Retaining Ring)</b>, Keyed, Silver Body</p>
	<p><b>AHDM06-18-14SR-059</b> - Shell Size 18, 14 Pos, <b>Plug</b>, Socket, DuraMate™ AHDM Series, Metal, Reduced Diameter Rear Seal (Red), <b>Backshell w Cable Clamp</b></p> <p><b>AHDM04-18-14SR-059</b> - Shell Size 18, 14 Pos, <b>Recept</b>, Pin, DuraMate™ AHDM Series, Metal, Reduced Diameter Rear Seal (Red), <b>Backshell w Cable Clamp</b></p>
	<p><b>AHDM06-18-06PN-072</b> - Shell Size 18, 6 Pos, <b>Plug</b>, Pin, Size 4/16 Contacts, 4-20AWG, 100A/13A, 250V, DuraMate™ AHDM Series, Metal, Normal Diameter Rear Seal (Red), <b>Integrated Wide Thread (Green Retaining Ring)</b>, Silver Body, <b>Backshell w Weep Holes (AHDMBS-18-072)</b></p> <p><b>AHDM04-18-06PN-072</b> - Shell Size 18, 6 Pos, <b>Recept</b>, Pin, Size 4/16 Contacts, 4-20AWG, 100A/13A, 250V, DuraMate™ AHDM Series, Metal, Normal Diameter Rear Seal (Red), <b>Integrated Wide Thread (Green Retaining Ring)</b>, Silver Body, <b>Backshell w Weep Holes (AHDMBS-18-072)</b></p>
	<p><b>AHDM06-18-06PN-L005</b> - Shell Size 18, 6 Pos, <b>Plug</b>, Pin, Size 4/16 Contacts, 4-20AWG, 100A/13A, 250V, DuraMate™ AHDM Series, Metal, Normal Diameter Rear Seal (Red), <b>Integrated Wide Thread (Green Retaining Ring)</b>, Silver Body, <b>Backshell w/out Weep Holes (AHDMBS-18-L005)</b></p> <p><b>AHDM04-18-06PN-L005</b> - Shell Size 18, 6 Pos, <b>Recept</b>, Pin, Size 4/16 Contacts, 4-20AWG, 100A/13A, 250V, DuraMate™ AHDM Series, Metal, Normal Diameter Rear Seal (Red), <b>Integrated Wide Thread (Green Retaining Ring)</b>, Silver Body, <b>Backshell w/out Weep Holes (AHDMBS-18-L005)</b></p>
	<p><b>AHDP06-18-06SN-BRA</b> - Shell Size 18, 6 Pos, <b>Plug</b>, Socket, DuraMate™ AHDP, Plastic, Normal Diameter Rear Seal (Red), <b>Backshell Ring Adapter BRA (Green)</b></p> <p><b>AHDP04-18-06PN-BRA</b> - Shell Size 18, 6 Pos, <b>Recept</b>, Pin, DuraMate™ AHDP, Plastic, Normal Diameter Rear Seal (Red), <b>Backshell Ring Adapter BRA (Green)</b></p>
	<p><b>AHDP06-18-20SN-SRA</b> - Shell Size 18, 20 Pos, <b>Plug</b>, Socket, DuraMate™ AHDP, Plastic, Normal Diameter Rear Seal (Red), <b>Smooth Ring Adapter SRA (Green)</b></p> <p><b>AHDP04-18-20PN-SRA</b> - Shell Size 18, 20 Pos, <b>Recept</b>, Pin, DuraMate™ AHDP, Plastic, Normal Diameter Rear Seal (Red), <b>Smooth Ring Adapter SRA (Green)</b></p>
	<p><b>AHDP06-24-27PR-STA</b> - Shell Size 24, 27 Pos, <b>Plug</b>, Pin, DuraMate™ AHDP, Plastic, Reduced Diameter Rear Seal (Red), <b>Small Thread Adapter STA (Blue)</b></p> <p><b>AHDP04-24-27SR-STA</b> - Shell Size 24, 27 Pos, <b>Recept</b>, Socket, DuraMate™ AHDP, Plastic, Reduced Diameter Rear Seal (Red), <b>Small Thread Adapter STA (Blue)</b></p>
	<p><b>AHDP06-24-23ST-WTA</b> - Shell Size 24, 23 Pos, <b>Plug</b>, Socket, DuraMate™ AHDP, Plastic, Thin Diameter Rear Seal (Red), <b>Wide Thread Adapter WTA (Grey)</b></p> <p><b>AHDP04-24-23PT-WTA</b> - Shell Size 24, 23 Pos, <b>Recept</b>, Pin, DuraMate™ AHDP, Plastic, Thin Diameter Rear Seal (Red), <b>Wide Thread Adapter WTA (Grey)</b></p>



# DM Dura|Mate™ AHDP

## Environmentally-Sealed, Multi-Pin, Heavy-Duty, Plastic, Circular Connectors



Available in Shell Size 18 with 8 insert arrangements 2, 6, 8, 14(x3), 20 and 21

Available in Shell Size 24 with 17 insert arrangements 3, 7(x2), 9, 14, 16, 18(x2), 19, 21, 23, 27, 29, 31, 33, 35 and 47

Amphenol Sine Systems' **DuraMate™ AHDP** connectors are an environmentally-sealed, multi-pin, heavy duty, plastic, circular connector with IP68 and IP69K ratings (in mated condition) that contains a circular bayonet locking system manufactured to withstand the challenges and complexities of harsh environment off-road applications. Available in the following options: **DuraMate™ AHDP with PanelMate™** and **DuraMate™ AHDP with HYPERBUSS™**.



### Key Features

- 3 keyway circular bayonet design ensures proper mating of connectors
- High density signal and mixed power insert configurations
- High current configurations incorporating revolutionary RADSOK® contacts
- Low insertion force stamped terminals offer improved manufacturing efficiencies
- Sealing features consisting of durable high temperature silicone provide barrier from lubricating oils, hydraulic fluids and fossil fuels
- Backshells maintain a compression-fit design to resist maximum pull-out forces and facilitate strain-relief for jacketed cable ranges.
- Wire entry sealing available in four separate ranges for discrete wire applications
- Environmentally-sealed and engineered rapid and secure mating system achieves up to IP69K rating (in mated condition) from ingress of dust, water, mud and other contaminants and is vibration resistant
- Smooth Ring Adapters (SRA) are designed for use without backshells for a smaller footprint
- Small Thread Adapters (STA) provide an enhanced "step down" threading for use with screw-on or clamshell backshells
- Wide Thread Adapters (WTA) provide an enhanced threading for use with our wide variety of screw-on or clamshell backshells
- Backshell Ring Adapters (BRA) allow for use with other compatible industry-standard snap-on backshells
- Utilizes A Series™ standard contact system (Stamped & Formed or Machined)



DuraMate™ AHDP - Specifications (Reference Individual Datasheets)

IP Rating (in mated condition)	IP68 and IP69K
Max. Current (Amperage)	Size 4 - 100A / Size 4+ - 100A Size 8 - 60A / Size 8 RADSOK - 80A Size 12 - 25A Size 16 - 13A Size 20 - 7.5A
Max. Voltage Rating	250V
Operating Temperature	-55°C to +125°C
Coupling System	Circular Bayonet
Housing Body	Thermoplastic UL94-VO
Insulation Insert	Thermoplastic UL94-VO

Contact Types	Stamped & Formed, Machined
Contact Material	Copper Alloy
Sealing Material	Silicone Rubber
Min. Mating Cycles	>100
Flammability Rating	UL94-VO
Fluid Resistance	Gas, oil, mineral oil, acid bath, basic bath
RoHS Compliant	ALL materials meet the requirements of the European Directive. (See website for documentation)

### IP Ratings

- IP67 rated (Dust tight; 1M of Water for 30 Minutes, in mated condition)
- IP68 rated (Dust tight; 1M of Water for 24 Hours, in mated condition)
- IP69K rated (Dust tight; High-Pressure Waterproof, 4 Points (0°, 30°, 60°, 90°), in mated condition)



Standard products. Custom solutions  
Customer Service +1 800 394 7732

DuraMate™ AHDP - Insert Arrangements

(1) C030 - 6 Pos/2 Used (Size 4); (2) C041 - Recep w Diagnostic Keying; (3) CL20 - Plug w Diagnostic Keying; (4) CL22 - Alt. Layout; (5) CL82 - Alt. Layout; (6) C031 - Alt. Layout

Shell Size 18	Shell Size 18	Shell Size 18	Shell Size 18	Shell Size 18	Shell Size 18	Shell Size 18	Shell Size 18	Shell Size 24	Shell Size 24
18-06 (1) 2 x Size 4 (N)	18-06 2 x Size 4, 4 x Size 16 (N)	18-08 8 x Size 12 (N) (R)	18-14 14 x Size 16 (N) (R)	18-14 (2) 14 x Size 16 (R)	18-14 (3) 14 x Size 16 (R)	18-20 2 x Size 16, 18 x Size 20 (N) (R)	18-21 21 x Size 20 (N)	24-03 (6) 3 x Size 4 (N)	24-07 1 x Size 8 (RADSOK®) 6 x Size 12 (N)

Shell Size 24	Shell Size 24	Shell Size 24	Shell Size 24	Shell Size 24	Shell Size 24	Shell Size 24	Shell Size 24	Shell Size 24	Shell Size 24
24-07 (4) 3 x Size 4, 4 x Size 16 (N)	24-09 1 x Size 4, 2 x Size 8 6 x Size 12 (N) (R)	24-14 1 x Size 4, 1 x Size 12 12 x Size 16 (N) (R)	24-16 16 x Size 12 (N) (R)	24-18 1 x Size 8, 3 x Size 12 14 x Size 16 (N) (R)	24-18 (5) 2 x Size 8, 16 x Size 20 (N)	24-19 6 x Size 12, 13 x Size 16 (N) (R)	24-21 4 x Size 12, 17 x Size 16 (N) (R)	24-23 23 x Size 16 (N) (T) (R)	24-27 4 x Size 12, 23 x Size 16 (R)

Shell Size 24	Shell Size 24	Shell Size 24	Shell Size 24	Shell Size 24
24-29 4 x Size 12, 19 x Size 16 6 x Size 20 (R)	24-31 31 x Size 16 (T) (R)	24-33 33 x Size 20 (N)	24-35 3 x Size 16, 32 x Size 20 (R)	24-47 5 x Size 16, 42 x Size 20 (R)

Contact Legend (Size/Amp)					
Size 4 or 4+ 100A	Size 8 60A	Size 8 RADSOK® 80A	Size 12 25A	Size 16 13A	Size 20 7.5A

DuraMate™ AHDP - Recommended Wire Insulation Overall Diameter (OD)







4+ contact is only available for 24-07CL22





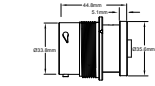

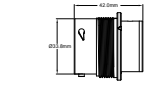

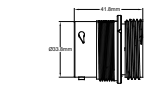
Contact Size	Typical Wire Range	(N) Normal Seal	(T) Thin Seal	(R) Reduced Seal (See datasheets)	
4+	4AWG (25.0-21.0mm <sup>2</sup> )	7.9-10.67mm (0.311-0.420")	-	-	-
4	6AWG (16.0-13.0mm <sup>2</sup> )	6.63-7.41mm (0.261-0.292")	-	6.63-7.41mm (0.261-0.292")	-
8	8-10AWG (10.0-5.0mm <sup>2</sup> )	4.83-6.10mm (0.190-0.240")	-	3.43-5.59mm (0.135-0.220")	-
12	10-14AWG (6.0-2.0mm <sup>2</sup> )	3.43-4.32mm (0.1350-.170")	-	2.46-4.01mm (0.135-0.158")	2.46-4.01mm (0.135-0.158")
16	14-20AWG (2.0-0.5mm <sup>2</sup> )	2.54-3.40mm (0.100-0.134")	2.23-2.69mm (0.088-.106")	1.35-3.05mm(0.053-0.120")	1.35-2.62mm (0.053-0.103")
20	16-22AWG (1.5-0.35mm <sup>2</sup> )	1.02-2.41mm (0.040-.095")	-	1.02-02.41mm (0.040-0.095")	1.02-2.10mm (0.040-0.083")

DuraMate™ AHDP - Backshell Options and Accessory Overview

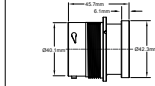

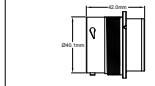

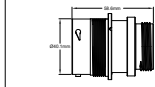

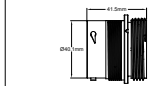
DuraMate™ AHDP - Plug & Receptacle Options (Dimensions in mm)

Shell Size 18 Plug		Shell Size 18 Receptacle	
Backshell Ring Adapter (BRA)			
Smooth Ring Adapter (SRA)			
-	-	-	-
Wide Thread Adapter (WTA)			

Shell Size 24 Plug		Shell Size 24 Receptacle	
Backshell Ring Adapter (BRA)			
Smooth Ring Adapter (SRA)			
Small Thread Adapter (STA)			
Wide Thread Adapter (WTA)			

DuraMate™ AHDP with PanelMate™ - Receptacle Options (Dimensions in mm)

		Shell Size 18 Receptacle	
-	-	PanelMate™ with Backshell Ring Adapter (BRA)	
-	-	PanelMate™ with Smooth Ring Adapter (SRA)	
-	-	-	-
-	-	PanelMate™ with Wide Thread Adapter (WTA)	

		Shell Size 24 Receptacle	
-	-	PanelMate™ with Backshell Ring Adapter (BRA)	
-	-	PanelMate™ with Smooth Ring Adapter (SRA)	
-	-	PanelMate™ with Wide Thread Adapter (STA)	
-	-	PanelMate™ with Wide Thread Adapter (WTA)	

DuraMate™ AHDP with HYPERBUS™ - Receptacle Option (Dimensions in mm)

\*For more information, refer to [HYPERBUS™ Family Literature](#)

-	-	-	-
-	-	-	-

		Shell Size 24 Receptacle	
-	-	HYPERBUS™ (Ground/Positive)	
-	-	-	-

DuraMate™ AHDP - Backshell Options and Accessories

Note: Refer to individual datasheets on [www.amphenol-sine.com](http://www.amphenol-sine.com) for full specs, faceviews, keying location and product dimensions.

















Image	Part Number	Description
	AHDPBS-015-1805	Shell Size 18, Backshell, Conduit, Snap Over, Right Angle, DuraMate™ AHDP, Black Body Note: For use with AHDP04/06-18-*P/S-WTA Wide Thread Adapter. Designed for Corrugated Tube NW 13,17 and 19
	AHDPBS-15L017-1805	Shell Size 18, Backshell, Conduit, Snap Over, Right Angle, DuraMate™ AHDP, Black Body Note: For use with AHDP02/04/06-18-*P/S-BRA Backshell Ring Adapter. Designed for Corrugated Tube NW 13,17 and 19
	AHDPBS-016-1805	Shell Size 18, Backshell, Conduit, Snap Over, Straight, DuraMate™ AHDP, Black Body Note: For use with AHDP04/06-18-*P/S-WTA Wide Thread Adapter. Designed for Corrugated Tube NW 13,17 and 19
	AHDPBS-16L017-1805	Shell Size 18, Backshell, Conduit, Snap-Over, Straight, DuraMate™ AHDP, Black Body Note: For use with AHDP02/04/06-18-*P/S-BRA Backshell Ring Adapter. Designed for Corrugated Tube NW 13,17 and 19
	AHDPBS-18-001	Shell Size 18, Backshell, Tie Wrap, Wide Thread Adapter (WTA), DuraMate™ AHDP, Black Body Note: For use with Wide Thread Adapter (WTA)
	AHDPBS-18-002	Shell Size 18, Backshell, Wide Thread Adapter (WTA), 2PC, Compression Nut, DuraMate™ AHDP, Black Body Note: For use with Wide Thread Adapter (WTA). Cable Size Range: 14.5 ~ 18.0
	AHDPBS-18-SM01	Shell Size 18, Backshell, Silicone Rubber Ring, Clamp/Nut, DuraMate™ AHDP, Black Body Note: For use with Wide Thread Adapter (WTA)
	AHDPBS-008-2405	Shell Size 24, Backshell, Straight, DuraMate™ AHDP, Black Body Note: For use with AHDP02-24-*BRA, AHDP04-24-*BRA, AHDP06-24-*BRA Backshell Ring Adapter. Designed for Corrugated Tube NW 25.4
	AHDPBS-11L017-2405	Shell Size 24, Backshell, Conduit, Snap-Over, Right Angle, DuraMate™ AHDP, Black Body Note: For use with AHDP04/06-24-*P/S-WTA Wide Thread Adapter. Designed for Corrugated Tube NW 17,19 and 26
	AHDPBS-010-2405	Shell Size 24, Backshell, Conduit, Snap Over, Straight, DuraMate™ AHDP, Black Body Note: For use with AHDP04/06-24-*P/S-WTA Wide Thread Adapter. Designed for Corrugated Tube NW 17,19 and 26
	AHDPBS-10L017-2405	Shell Size 24, Backshell, Conduit, Snap-Over, Straight, DuraMate™ AHDP, Black Body Note: For use with AHDP02/04/06-24-*P/S-BRA Backshell Ring Adapter. Designed for Corrugated Tube NW 17,19 and 26
	AHDPBS-0406-001	Shell Size 24, Backshell, Tie Wrap, Wide Thread Adapter (WTA), DuraMate™ AHDP, Black Body Note: For use with Wide Thread Adapter (WTA)
	AHDPBS-24L015-005	Shell Size 24, Backshell, Small Thread Adapter (STA), 2PC, Compression Nut, DuraMate™ AHDP, Black Body Note: For use with Small Thread Adapter (STA). Cable Size Range: 14.5 ~ 18.0
	AHDPBS-0406-002	Shell Size 24, Backshell, Wide Thread Adapter (WTA), 2 PC, Compression Nut, DuraMate™ AHDP, Black Body Note: For use with Wide Thread Adapter (WTA). Cable Size Range: 14.5 ~ 18.0
	AHDPBS-0406-003	Shell Size 24, Backshell, Wide Thread Adapter (WTA), 2 PC, Compression Nut, DuraMate™ AHDP, Black Body Note: For use with Wide Thread Adapter (WTA). Cable Size Range: 19.5 ~ 24.1
	AHDPBS-0406-SM01	Shell Size 24, Backshell, Silicone Rubber Ring, Clamp/Nut, DuraMate™ AHDP, Black Body Note: For use with Wide Thread Adapter (WTA)

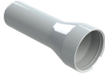



























Image	Part Number	Description
	AHDPM18-BT	Shell Size 18, Boot, DuraMate™ AHDP (SRA only) & DuraMate™ AHDM, Grey Body
	AHDPM18-BT-BK	Shell Size 18, Boot, DuraMate™ AHDP (SRA only) & DuraMate™ AHDM, Black Body
	AHDPM18-BT-RA	Shell Size 18, Right Angle Boot, DuraMate™ AHDP (SRA only) & DuraMate™ AHDM, Grey Body
	AHDPM18-BT-RA-BK	Shell Size 18, Right Angle Boot, DuraMate™ AHDP (SRA only) & DuraMate™ AHDM, Black Body
	AHDPM24-BT	Shell Size 24, Boot, DuraMate™ AHDP (SRA only) & DuraMate™ AHDM, Grey Body
	AHDPM24-BT-BK	Shell Size 24, Boot, DuraMate™ AHDP (SRA only) & DuraMate™ AHDM, Black Body
	AHDPM24-BT-RA	Shell Size 24, Right Angle Boot, DuraMate™ AHDP (SRA only) & DuraMate™ AHDM, Grey Body
	AHDPM24-BT-RA-BK	Shell Size 24, Right Angle Boot, DuraMate™ AHDP (SRA only) & DuraMate™ AHDM, Black Body
	AHDC06-18	Shell Size 18, Receptacle Cap, Sealed, DuraMate™ AHDP, Black Body
	AHDC06-24	Shell Size 24, Receptacle Cap, Sealed, DuraMate™ AHDP, Black Body
	AHDC04-18	Shell Size 18, Plug Cap, Sealed, DuraMate™ AHDP, Black Body
	AHDC04-24	Shell Size 24, Plug Cap, Sealed, DuraMate™ AHDP, Black Body
	AHDC04-24-PM	Shell Size 24, Plug Cap, Sealed, Threaded, DuraMate™ AHDP, Black Body
	AHDC04-24-PMT	Shell Size 24, Plug Cap, w Tether, Threaded, Lock Washer, Sealed, DuraMate™ AHDP, Black Body
	AHDC04-18-T	Shell Size 18, Plug Cap, w Tether, Sealed, DuraMate™ AHDP, Black Body
	AHDC04-24-T	Shell Size 24, Plug Cap, w Tether, Sealed, DuraMate™ AHDP, Black Body
	AHDPSCC-24	Shell Size 24, Self-Closing Protective Cap, DuraMate™ AHDP and DuraMate™ AHDP ISOBUS 91 Series, Black Body
	AHDP18-PN01	Shell Size 18, Panel Nut, DuraMate™ AHDP, Black Body
	AHDP24-PN01	Shell Size 24, Panel Nut, DuraMate™ AHDP, Black Body

Image	Part Number	Description
	AT14-002-1886	Shell Size 18, Lock Washer, Wave, DuraMate™ AHDP, Silver Body
	AT14-001-2486	Shell Size 24, Lock Washer, Wave, DuraMate™ AHDP, Silver Body
	AHDP-16-04978	Shell Size 18, Rubber Flange Seal, DuraMate™ AHDP and DuraMate™ AHDM, Black Body
	AHDP-16-04477	Shell Size 24, Rubber Flange Seal, DuraMate™ AHDP and DuraMate™ AHDM, Black Body
	A114019	Contact Size 4, Blank Seal Plug, Red Body
	A114018	Contact Size 8, Blank Seal Plug, White Body
	A114017	Contact Size 12/16, Blank Seal Plug, White Body
	AT13-217-1605	Contact Size 16, Locking Seal Plug, White Body
	AT13-204-2005	Contact Size 20, Blank Seal Plug, White Body
	AT11-027-0405	Contact Size 4+, Contact Removal Tool, 4AWG, Black Body
	AT114009	Contact Size 4, Contact Removal Tool, 6AWG, White Body
	AT11-001-3.6M	Contact Size 8, Contact Removal Tool, 7-10AWG, Black Body
	AT114008	Contact Size 8, Contact Removal Tool, 8-10AWG, Green Body
	AT11-337-1205	Contact Size 12, Contact Removal Tool, 12-14AWG, Orange Body
	AT11-310-1605	Contact Size 16, Contact Removal Tool, 16-20AWG, Turquoise Body
	AT11-240-2005	Contact Size 20, Contact Removal Tool, 20-22AWG, Red Body



# DM Dura|Mate™ AHDP with HYPERBUSS™



## DuraMate™ AHDP Bussed Receptacles

Available in 16 position

Amphenol Sine Systems' **DuraMate™ AHDP with HYPERBUSS™ Bussed Receptacles** are an environmentally-sealed, multi-pin, heavy duty, plastic, circular connector for use in applications where a common "bussed" electrical pathway is required, such as Bussed Feedback Receptacles used as a Splice Block or Tap Block. IP68 and IP69K rated (in mated condition), the DuraMate™ AHDP with HYPERBUSS™ Bussed Receptacles contain a circular, bayonet locking system to ensure proper mating with standard DuraMate™ AHDP plugs, as well as industry standard connectors.

**Buss:** a conductor, or a group of conductors, used for collecting electric power from the incoming feeders and distributes them to the outgoing feeders; a type of electrical junction in which all the incoming and outgoing electrical current meets.

### Key Features

- Includes Bolt, Nut and Washers
- Available in Power (Red) or Ground (Black)
- Sealed (potted) Intergrated Bussed Feedback Assembly
- IP68 and IP69K rated (in mated condition)
- Circular, bayonet coupling system
- Intermateable with standard DuraMate™ AHDP plugs



**Applications:** Heavy Duty, Transportation, Marine, Military, Alternative Energy, Agricultural and other interconnect

DuraMate™ AHDP w HYPERBUSS™ - Specifications (Reference Individual Datasheets)

IP Rating (in mated condition)	IP68 and IP69K
Max. Current (Amperage)	25A Each (400A Max)
Max. Voltage Rating	250V
Operating Temperature	-55°C to +125°C
Coupling System	Circular Bayonet
Housing Body	Thermoplastic UL94-VO
Insulation Insert	Thermoplastic UL94-VO
Contact Types	Machined
Contact Material	Copper Alloy
Bracket	Copper Alloy, Nickel Plated
Sleeves	Aluminum, Black Anodized
Min. Mating Cycles	>100
Flammability Rating	UL94-VO
Fluid Resistance	Gas, oil, mineral oil, acid bath, basic bath
RoHS Compliant	ALL materials meet the requirements of the European Directive. (See website for documentation)

### IP Ratings

- IP67 rated (Dust tight; 1M of Water for 30 Minutes, in mated condition)
- IP68 rated (Dust tight; 1M of Water for 24 Hours, in mated condition)
- IP69K rated (Dust tight; High-Pressure Waterproof, 4 Points (0°, 30°, 60°, 90°), in mated condition)



Standard products. Custom solutions  
Customer Service +1 800 394 7732

DuraMate™ AHDP with HYPERBUSSTM - 16 Position Bussed Receptacle Dimensions (mm)

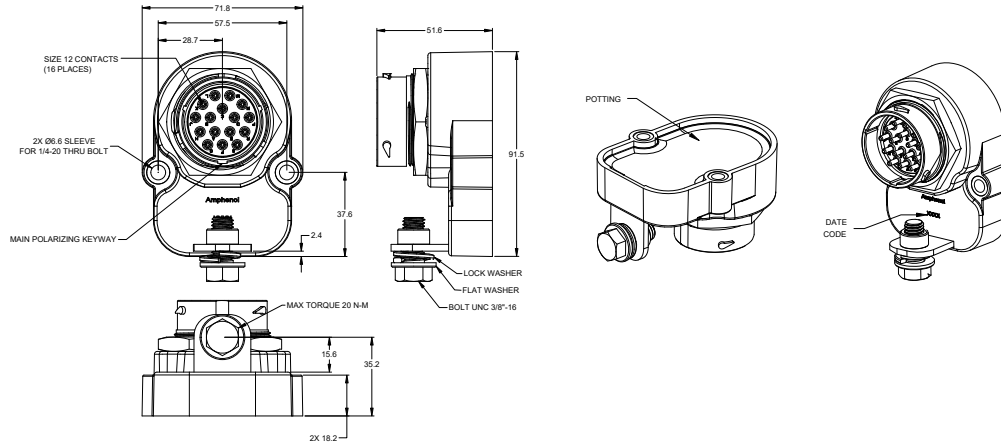

DuraMate™ AHDP with HYPERBUSSTM - 16 Position Bussed Receptacles [For intermateable DuraMate™ AHDP Series plugs \(AHP06-\), refer to our website](#)  
 Note: Refer to individual datasheets on [www.amphenol-sine.com](http://www.amphenol-sine.com) for full specs, faceviews, keying location and product dimensions.

Image	Pin Layout/Image	Part Number	Description	Contact Size	Amperage
	<p>-16P</p>	AHDPH04-24-16P-BLK-CN	Shell Size 24, 16 Position, Receptacle, Size 12 Contacts, (1) 16 Pin (400A), DuraMate™ AHDP with HYPERBUSSTM, Plastic, Potted, Black Body (Includes bolt, nut and washers)	12	25A (400A Max)
		AHDPH04-24-16P-RED-CN	Shell Size 24, 16 Position, Receptacle, Size 12 Contacts, (1) 16 Pin (400A), DuraMate™ AHDP with HYPERBUSSTM, Plastic, Potted, Red Body (Includes bolt, nut and washers)	12	25A (400A Max)



# DM Dura|Mate™ AHDP ISOBUS 91 Series

## Environmentally-Sealed, Multi-Pin, Heavy-Duty, Plastic Circular ISOBUS Connectors



Available in Shell Size 24, 9 Position

Amphenol Sine Systems' **DuraMate™ AHDP ISOBUS 91 Series** connectors are an environmentally-sealed, multi-pin, heavy duty, plastic, circular connector with IP68 and IP69K ratings (in mated condition) that contains a circular bayonet locking system manufactured to withstand the challenges and complexities of harsh environment, off-road applications. *The DuraMate™ AHDP ISOBUS 91 Series is specifically designed to meet ISO 11783 standards (for control and communications between tractors, implements and software) and withstand the challenges and complexities of harsh environment, off-road, agricultural applications.*

### Key ISOBUS 91 Series Features

- + **One-to-one alternative for all HDP20 parts**
- + **Compatible to other industry standard circular bayonet versions**
- + **AHDP 91 Series Plugs have a jumper (bridged contacts) between Pin 4 & 5. (-P064 options have no jumper (bridged contacts) between Pin 4 & 5.)**
- + **AHDP 91 Series Receptacles do not have a jumper (bridged contact)**
- + **Options for up to 6AWG/16mm<sup>2</sup> power wires**
- + **Full range of backshell options**

### Key DuraMate™ Features

- 3 key-way circular bayonet design ensures proper mating of connectors
- High density signal and mixed power insert configurations
- Operating temperature range: -55°C to +125°C
- High-strength, impact resistant & lightweight thermoplastic housings
- Low-insertion force stamped terminals offer improved manufacturing efficiencies
- Environmentally-sealed and engineered rapid and secure mating system achieves up to IP69K rating (in mated condition) from ingress of dust, water, mud and other contaminants and is vibration resistant
- Sealing features consisting of durable high-temperature silicone provide barrier from lubricating oils, hydraulic fluids and fossil fuels
- Backshells maintain a compression-fit design to resist maximum pull-out forces and facilitate strain-relief for jacketed cable ranges
- Wire entry sealing available in four separate ranges for discrete wire applications
- Smooth Ring Adapters (SRA) are designed for use without backshells for a smaller footprint
- Small Thread Adapters (STA) provide an enhanced "step down" threading for use with screw-on or clamshell backshells
- Wide Thread Adapters (WTA) provide an enhanced threading for use with our wide variety of screw-on or clamshell backshells
- Utilizes A Series™ standard contact system (Stamped & Formed or Machined)



DuraMate™ AHDP ISOBUS 91 Series - Specifications (Reference Individual Datasheets)

IP Rating (in mated condition)	IP68 and IP69K
Max. Current (Amperage)	Size 8, 60A Size 12, 25A Size 16, 13A
Max. Voltage Rating	250V
Operating Temperature	-55°C to +125°C
Coupling System	Circular Bayonet
Housing Body	Thermoplastic UL94-VO
Insulation Insert	Thermoplastic UL94-VO

Contact Types	Stamped & Formed, Machined
Contact Material	Copper Alloy
Sealing Material	Silicone Rubber
Min. Mating Cycles	>100
Flammability Rating	UL94-VO
Fluid Resistance	Gas, oil, mineral oil, acid bath, basic bath
RoHS Compliant	ALL materials meet the requirements of the European Directive. (See website for documentation)

### IP Ratings

- IP67 rated (Dust tight; 1M of Water for 30 Minutes, in mated condition)
- IP68 rated (Dust tight; 1M of Water for 24 Hours, in mated condition)
- IP69K rated (Dust tight; High-Pressure Waterproof, 4 Points (0°, 30°, 60°, 90°), in mated condition)



Standard products. Custom solutions  
Customer Service +1 800 394 7732

DuraMate™ AHDP ISOBUS 91 Series - Insert Arrangements

Shell Size 24	Contact Legend (Size/Amp)			
24-91 2 x Size 8, 2 x Size 12, 5 x Size 16 (N) (R)				
	Size 8 (6AWG) 60A	Size 8 (8-10AWG) 60A	Size 12 25A	Size 16 13A

DuraMate™ AHDP ISOBUS 91 Series - Recommended Wire Insulation Overall Diameter (OD)

Contact Size	Typical Wire Range	(N) Normal Seal	(R) Reduced Seal	(R) Reduced Seal for 6AWG/16mm <sup>2</sup> (Size 8 Contacts Only)
8	6-10AWG (5.0-16.0mm <sup>2</sup> )	4.83-6.10mm (0.190-0.240")	3.43-5.59mm (0.135-0.220")	6.50-7.42mm (0.256-0.292")
12	10-14AWG (6.0-2.0mm <sup>2</sup> )	3.40-4.32mm (0.134-0.170")	2.46-4.01mm (0.135-0.158")	2.46-4.01mm (0.135-0.158")
16	14-20AWG (2.0-0.5mm <sup>2</sup> )	2.54-3.40mm (0.100-0.134")	1.35-3.05mm (0.053-0.120")	1.35-3.05mm (0.053-0.120")z

DuraMate™ AHDP ISOBUS 91 Series - Backshell Options and Accessory Overview



DuraMate™ AHDP ISOBUS 91 Series - Plug & Receptacle Options (Dimensions in mm)

Shell Size 24 Plug		Shell Size 24 Receptacle		Shell Size 24 Plug		Shell Size 24 Receptacle	
Smooth Ring Adapter (SRA)		Smooth Ring Adapter (SRA)		Small Thread Adapter (STA)		Small Thread Adapter (STA)	
Wide Thread Adapter (WTA)		Wide Thread Adapter (WTA)					

DuraMate™ AHDP ISOBUS 91 Series - Plugs



Note: Refer to individual datasheets on [www.amphenol-sine.com](http://www.amphenol-sine.com) for full specs, faceviews, keying location and product dimensions.

Image	Part Number	Description	Contact Size/Amp	Voltage
	AHDP06-24-91SN-SRA	Shell Size 24, 9 Position, Plug, Socket, DuraMate™ AHDP ISOBUS 91 Series, Plastic, Normal Diameter Seal (Green), Smooth Ring Adapter (SRA)	Size 8, 60A Size 12, 25A Size 16, 13A	250V
	AHDP06-24-91SN-STA	Shell Size 24, 9 Position, Plug, Socket, DuraMate™ AHDP ISOBUS 91 Series, Plastic, Normal Diameter Seal (Green), Small Thread Adapter (STA)	Size 8, 60A Size 12, 25A Size 16, 13A	250V
	AHDP06-24-91SN-WTA	Shell Size 24, 9 Position, Plug, Socket, DuraMate™ AHDP ISOBUS 91 Series, Plastic, Normal Diameter Seal (Green), Wide Thread Adapter (WTA)	Size 8, 60A Size 12, 25A Size 16, 13A	250V
	AHDP06-24-91SR-SRA	Shell Size 24, 9 Position, Plug, Socket, DuraMate™ AHDP ISOBUS 91 Series, Plastic, Reduced Diameter Seal (Blue), Smooth Ring Adapter (SRA)	Size 8, 60A Size 12, 25A Size 16, 13A	250V
	AHDP06-24-91SR-STA	Shell Size 24, 9 Position, Plug, Socket, DuraMate™ AHDP ISOBUS 91 Series, Plastic, Reduced Diameter Seal (Blue), Small Thread Adapter (STA)	Size 8, 60A Size 12, 25A Size 16, 13A	250V
	AHDP06-24-91SR-WTA	Shell Size 24, 9 Position, Plug, Socket, DuraMate™ AHDP ISOBUS 91 Series, Plastic, Reduced Diameter Seal (Blue), Wide Thread Adapter (WTA)	Size 8, 60A Size 12, 25A Size 16, 13A	250V
	AHDP06-24-91SR16-SRA	Shell Size 24, 9 Position, Plug, Socket, DuraMate™ AHDP ISOBUS 91 Series, Plastic, Reduced Diameter Seal (Blue), Smooth Ring Adapter (SRA), Size 8 Contact, 6AWG/16mm² Wire Seal Note: Use AT62-203-08141-16 contacts for 6AWG/16mm² applications	Size 8, 60A Size 12, 25A Size 16, 13A	250V
	AHDP06-24-91SR16-STA	Shell Size 24, 9 Position, Plug, Socket, DuraMate™ AHDP ISOBUS 91 Series, Plastic, Reduced Diameter Seal, Small Thread Adapter STA (Blue), Size 8 Contact, 6AWG/16mm² Wire Seal	Size 8, 60A Size 12, 25A Size 16, 13A	250V
	AHDP06-24-91SR16-WTA	Shell Size 24, 9 Position, Plug, Socket, DuraMate™ AHDP ISOBUS 91 Series, Plastic, Reduced Diameter Seal (Blue), Wide Thread Adapter (WTA), Size 8 Contact, 6AWG/16mm² Wire Seal Note: Use AT62-203-08141-16 contacts for 6AWG/16mm² applications	Size 8, 60A Size 12, 25A Size 16, 13A	250V
	AHDP06-24-91SN-P064	Shell Size 24, 9 Position, Plug, Socket, DuraMate™ AHDP ISOBUS 91 Series, Plastic, Normal Diameter Seal, Smooth Ring Adapter (SRA) (Green) <b>No Jumper (Bridged Contacts) Between Pin 4 &amp; 5</b>	Size 8, 60A Size 12, 25A Size 16, 13A	250V
	AHDP06-24-91SR-P064	Shell Size 24, 9 Position, Plug, Socket, DuraMate™ AHDP ISOBUS 91 Series, Plastic, Reduced Diameter Seal, Smooth Ring Adapter (SRA) (Green) <b>No Jumper (Bridged Contacts) Between Pin 4 &amp; 5</b>	Size 8, 60A Size 12, 25A Size 16, 13A	250V

DuraMate™ AHDP ISOBUS 91 Series - Receptacles

Note: Refer to individual datasheets on [www.amphenol-sine.com](http://www.amphenol-sine.com) for full specs, faceviews, keying location and product dimensions.

Image	Part Number	Description	Contact Size/Amp	Voltage
	AHDP04-24-91PN-SRA	Shell Size 24, 9 Position, Receptacle, Pin, DuraMate™ AHDP ISOBUS 91 Series, Plastic, Normal Diameter Seal (Green), Smooth Ring Adapter (SRA)	Size 8, 60A Size 12, 25A Size 16, 13A	250V
	AHDP04-24-91PN-STA	Shell Size 24, 9 Position, Receptacle, Pin, DuraMate™ AHDP ISOBUS 91 Series, Plastic, Normal Diameter Seal, Small Thread Adapter STA (Green)	Size 8, 60A Size 12, 25A Size 16, 13A	250V
	AHDP04-24-91PN-WTA	Shell Size 24, 9 Position, Receptacle, Pin, DuraMate™ AHDP ISOBUS 91 Series, Plastic, Normal Diameter Seal (Green), Wide Thread Adapter (WTA)	Size 8, 60A Size 12, 25A Size 16, 13A	250V







Image	Part Number	Description	Contact Size/Amp	Voltage
	AHDPO4-24-91PR-SRA	Shell Size 24, 9 Position, Receptacle, Pin, DuraMate™ AHDP ISOBUS 91 Series, Plastic, Reduced Diameter Seal (Blue), Smooth Ring Adapter (SRA)	Size 8, 60A Size 12, 25A Size 16, 13A	250V
	AHDPO4-24-91PR-STA	Shell Size 24, 9 Position, Receptacle, Pin, DuraMate™ AHDP ISOBUS 91 Series, Plastic, Reduced Diameter Seal, Small Thread Adapter STA (Blue)	Size 8, 60A Size 12, 25A Size 16, 13A	250V
	AHDPO4-24-91PR-WTA	Shell Size 24, 9 Position, Receptacle, Pin, DuraMate™ AHDP ISOBUS 91 Series, Plastic, Reduced Diameter Seal (Blue), Wide Thread Adapter (WTA)	Size 8, 60A Size 12, 25A Size 16, 13A	250V
	AHDPO4-24-91PR16-SRA	Shell Size 24, 9 Pos, Receptacle, Pin, DuraMate™ AHDP ISOBUS 91 Series, Plastic, Reduced Diameter Seal (Blue), Smooth Ring Adapter (SRA), Size 8 Contact, 6AWG/16mm² Wire Seal Note: Use AT60-204-08141-16 contacts for 6AWG/16mm² applications	Size 8, 60A Size 12, 25A Size 16, 13A	250V
	AHDPO4-24-91PR16-STA	Shell Size 24, 9 Position, Receptacle, Pin, DuraMate™ AHDP ISOBUS 91 Series, Plastic, Reduced Diameter Seal, Small Thread Adapter STA (Blue), Size 8 Contact, 6AWG/16mm² Wire Seal	Size 8, 60A Size 12, 25A Size 16, 13A	250V
	AHDPO4-24-91PR16-WTA	Shell Size 24, 9 Position, Receptacle, Pin, DuraMate™ AHDP ISOBUS 91 Series, Plastic, Reduced Diameter Seal (Blue), Wide Thread Adapter (WTA), Size 8 Contact, 6AWG/16mm² Wire Seal Note: Use AT60-204-08141-16 contacts for 6AWG/16mm² applications	Size 8, 60A Size 12, 25A Size 16, 13A	250V

DuraMate™ AHDP ISOBUS 91 Series - Backshell Options and Accessories

Note: Refer to individual datasheets on [www.amphenol-sine.com](http://www.amphenol-sine.com) for full specs, faceviews, keying location and product dimensions.

Image	Part Number	Description
	AHDPBS-011-2405	Shell Size 24, Backshell, Conduit, Snap Over, Right Angle, DuraMate™ AHDP, Black Body Note: For use with AHDPO4/06-24-*P/S-WTA Wide Thread Adapter. Designed for Corrugated Tube NW 13, 17 and 19
	AHDPBS-11L017-2405	Shell Size 24, Backshell, Conduit, Snap Over, Right Angle, DuraMate™ AHDP, Black Body Note: For use with AHDPO2/04/06-24-*P/S-BRA Backshell Ring Adapter. Designed for Corrugated Tube NW 17, 19 and 26
	AHDPBS-010-2405	Shell Size 24, Backshell, Conduit, Snap Over, Straight, DuraMate™ AHDP, Black Body Note: For use with AHDPO4/06-24-*P/S-WTA Wide Thread Adapter. Designed for Corrugated Tube NW 17, 19 and 26
	AHDPBS-10L017-2405	Shell Size 24, Backshell, Conduit, Snap Over, Straight, DuraMate™ AHDP, Black Body Note: For use with AHDPO2/04/06-24-*P/S-BRA Backshell Ring Adapter. Designed for Corrugated Tube NW 17, 19 and 26
	AHDPBS-0406-001	Shell Size 24, Backshell, Tie Wrap, Wide Thread Adapter (WTA), DuraMate™ AHDP, Black Body Note: For use with Wide Thread Adapter (WTA).
	AHDPBS-0406-002	Shell Size 24, Backshell, Wide Thread Adapter (WTA), 2 PC, Compression Nut, DuraMate™ AHDP, Black Body Note: For use with Wide Thread Adapter (WTA). Cable Size Range: 14.5 ~ 18.0
	AHDPBS-0406-003	Shell Size 24, Backshell, Wide Thread Adapter (WTA), 2 PC, Compression Nut, DuraMate™ AHDP, Black Body Note: For use with Wide Thread Adapter (WTA). Cable Size Range: 19.5 ~ 24.1
	AHDPBS-24L015-005	Shell Size 24, Backshell, Small Thread Adapter (STA), 2 PC, Compression Nut, DuraMate™ AHDP, Black Body Note: For use with Small Thread Adapter (STA)
	AHDPBS-0406-SM01	Shell Size 24, Backshell, Silicone Rubber Ring, Clamp/Nut, DuraMate™ AHDP, Black Body Note: For use with Wide Thread Adapter (WTA)

Image	Part Number	Description
	AHDPM18-BT	Shell Size 18, Boot, DuraMate™ AHDP (SRA only) & DuraMate™ AHDM, Grey Body
	AHDPM18-BT-BK	Shell Size 18, Boot, DuraMate™ AHDP (SRA only) & DuraMate™ AHDM, Black Body
	AHDPM18-BT-RA	Shell Size 18, Right Angle Boot, DuraMate™ AHDP (SRA only) & DuraMate™ AHDM, Grey Body
	AHDPM18-BT-RA-BK	Shell Size 18, Right Angle Boot, DuraMate™ AHDP (SRA only) & DuraMate™ AHDM, Black Body
	AHDPM24-BT	Shell Size 24, Boot, DuraMate™ AHDP (SRA only) & DuraMate™ AHDM, Grey Body
	AHDPM24-BT-BK	Shell Size 24, Boot, DuraMate™ AHDP (SRA only) & DuraMate™ AHDM, Black Body
	AHDPM24-BT-RA	Shell Size 24, Right Angle Boot, DuraMate™ AHDP (SRA only) & DuraMate™ AHDM, Grey Body
	AHDPM24-BT-RA-BK	Shell Size 24, Right Angle Boot, DuraMate™ AHDP (SRA only) & DuraMate™ AHDM, Black Body
	AHDC06-24	Shell Size 24, Receptacle Cap, Sealed, DuraMate™ AHDP, Black Color
	AHDC04-24-PM	Shell Size 24, Plug Cap, Sealed, Threaded, DuraMate™ AHDP, Black Color
	AHDC04-24-PMT	Shell Size 24, Plug Cap, w Tether, Threaded, Lock Washer, Sealed, DuraMate™ AHDP, Black Color
	AHDPSCC-24	Shell Size 24, Self-Closing Protective Cap, DuraMate™ AHDP and DuraMate™ AHDM, Black Color
	AHDP24-PN01	Shell Size 24, Panel Nut, DuraMate™ AHDP, Black Color
	AT14-001-2486	Shell Size 24, Lock Washer, Wave, DuraMate™ AHDP, Silver Color
	AHDP-16-04477	Shell Size 24, Rubber Flange Seal, DuraMate™ AHDP and DuraMate™ AHDM, Black Color
	A114018	Contact Size 8, Blank Seal Plug, White Color
	A114017	Contact Size 12/16, Blank Seal Plug, White Color
	AT13-217-1605	Contact Size 16, Locking Seal Plug, White Color

	AT11-001-3.6M	Contact Size 8, Contact Removal Tool, 7-10AWG, Black Body
	AT114008	Contact Size 8, Contact Removal Tool, 8-10AWG, Green Body
	AT11-337-1205	Contact Size 12, Contact Removal Tool, 12-14AWG, Orange Body
	AT11-310-1605	Contact Size 16, Contact Removal Tool, 16-20AWG, Turquoise Body
	AT60-204-08141-16	Contact Size 8, 6AWG/16mm <sup>2</sup> Wire Range, Contact, Pin, Nickel-plated Note: Refer to Plug/Receptacle datasheets for a complete list of available contacts
	AT62-203-08141-16	Contact Size 8, 6AWG/16mm <sup>2</sup> Wire Range, Contact, Socket, Nickel-plated Note: Refer to Plug/Receptacle datasheets for a complete list of available contacts



# DM Dura|Mate™ AHDM

## Environmentally-Sealed, Multi-Pin, Heavy-Duty, Metal, Circular Connectors



Available in Shell Size 18 with 6 insert arrangements 2, 6, 8, 14, 20 and 21

Available in Shell Size 24 with 15 insert arrangements 7(x2), 9, 14, 16, 18, 19, 21, 23, 27, 29, 31, 33, 35 and 47

Amphenol Sine Systems' **DuraMate™ AHDM** connectors are an environmentally-sealed, multi-pin, heavy duty, metal, circular connector with IP68 and IP69K ratings (in mated condition) that contains either a circular bayonet locking system or blind mate option, manufactured to withstand the challenges and complexities of harsh environment off-road applications. Available in the following options: DuraMate™ AHDM/AHDBM ISOBUS 91 Series.

### DM Dura|Mate™ AHDM/AHDBM ISOBUS 91 Series

#### Key Features

- 3 key-way circular bayonet design, or blind mate option, ensures proper mating of connectors
- High density signal and mixed power insert configurations
- Operating temperature range: -55°C to +125°C
- High current configurations incorporating revolutionary RADSOK® contacts
- High strength impact resistant & lightweight zinc alloy or aluminum alloy metal housings
- Low insertion force stamped terminals offer improved manufacturing efficiencies
- Environmentally-sealed and engineered rapid and secure mating system achieves up to IP69K rating (in mated condition) from ingress of dust, water, mud and other contaminants and is vibration resistant
- Sealing features consisting of durable high temperature silicone provide barrier from lubricating oils, hydraulic fluids and fossil fuels
- Backshells maintain a compression-fit design to resist maximum pull-out forces and facilitate strain-relief for jacketed cable ranges.
- Utilizes A Series™ standard contact system (Stamped & Formed or Machined)
- Wire entry sealing available in three separate ranges for discrete wire applications
- Integrated Wide Threading provides an enhanced threading for use with our wide variety of screw-on or clamshell backshells
- Utilizes A Series™ standard contact system (Stamped & Formed or Machined)



DuraMate™ AHDM - Specifications (Reference Individual Datasheets)

IP Rating (in mated condition)	IP68 and IP69K
Max. Current (Amperage)	Size 4 - 100A / Size 4+ - 100A Size 8 - 60A / Size 8 RADSOK - 80A Size 12 - 25A Size 16 - 13A Size 20 - 7.5A
Max. Voltage Rating	250V
Operating Temperature	-55°C to +125°C
Coupling System	Circular Bayonet or Blind Mate
Housing Body	Zinc Alloy or Aluminum Alloy

Insulation Insert	Thermoplastic UL94-VO
Contact Types	Stamped & Formed, Machined
Contact Material	Copper Alloy
Sealing Material	Silicone Rubber
Min. Mating Cycles	>100
Flammability Rating	UL94-VO
Fluid Resistance	Gas, oil, mineral oil, acid bath, basic bath
RoHS Compliant	ALL materials meet the requirements of the European Directive. (See website for documentation)

#### IP Ratings

IP67 rated (Dust tight; 1M of Water for 30 Minutes, in mated condition)

IP68 rated (Dust tight; 1M of Water for 24 Hours, in mated condition)

IP69K rated (Dust tight; High-Pressure Waterproof, 4 Points (0°, 30°, 60°, 90°), in mated condition)



## DM Dura|Mate™ Family

Standard products. Custom solutions  
Customer Service +1 800 394 7732

DuraMate™ AHDM - Insert Arrangements  
(1) C030 - 6 Pos/2 Used (Size 4); (4) CL22 - Alt. Layout

Shell Size 18	Shell Size 18	Shell Size 18	Shell Size 18	Shell Size 18	Shell Size 18	Shell Size 24	Shell Size 24	Shell Size 24	Shell Size 24
18-06 (1) 2 x Size 4 (N)	18-06 2 x Size 4, 4 x Size 16 (N)	18-08 8 x Size 12 (N) (R)	18-14 14 x Size 16 (N) (R)	18-20 2 x Size 16, 4 x Size 20 (N) (R)	18-21 21 x Size 20 (N)	24-07 1 X Size 8 (RADSOK®) 6 X Size 12 (N)	24-07 (4) 3 X Size 4, 4 X Size 16 (N)	24-09 1 X Size 4, 2 X Size 8 6 X Size 12 (N) (R)	24-14 1 X Size 4, 1 X Size 12 12 X Size 16 (N) (R)

Shell Size 24	Shell Size 24	Shell Size 24	Shell Size 24	Shell Size 24	Shell Size 24	Shell Size 24	Shell Size 24	Shell Size 24	Shell Size 24
24-16 16 X Size 12 (N) (R)	24-18 1 X Size 8, 3 X Size 12 14 X Size 16 (N) (R)	24-19 6 X Size 12, 13 X Size 16 (N) (R)	24-21 4 X Size 12, 17 X Size 16 (N) (R)	24-23 23 X Size 16 (N) (T) (R)	24-27 4 X Size 12, 23 X Size 16 (R)	24-29 4 X Size 12, 19 X Size 16 6 X Size 20 (R)	24-31 31 X Size 16 (R) (T)	24-33 33 X Size 20 (N)	24-35 3 X Size 16, 32 X Size 20 (R)

Shell Size 24
24-47 5 X Size 16, 42 X Size 20 (R)

Contact Legend (Size/Amp)					
Size 4 or 4+ 100A	Size 8 60A	Size 8 RADSOK® 80A	Size 12 25A	Size 16 13A	Size 20 7.5A

DuraMate™ AHDM - Recommended Wire Insulation Overall Diameter (OD)  
4+ contact is only available for 24-07CL22

Contact Size	Typical Wire Range	(N) Normal Seal	(T) Thin Seal	(R) Reduced Seal (See datasheets)	
4+	4AWG (25.0-21.0mm²)	7.9-10.67mm (0.311-0.420")	-	-	-
4	6AWG (16.0-13.0mm²)	6.63-7.41mm (0.261-0.292")	-	6.63-7.41mm (0.261-0.292")	-
8	8-10AWG (10.0-5.0mm²)	4.83-6.10mm (0.190-0.240")	-	3.43-5.59mm (0.135-0.220")	-
12	10-14AWG (6.0-2.0mm²)	3.43-4.32mm (0.1350-.170")	-	2.46-4.01mm (0.135-0.158")	2.46-4.01mm (0.135-0.158")
16	14-20AWG (2.0-0.5mm²)	2.54-3.40mm (0.100-0.134")	2.23-2.69mm (0.088-.106")	1.35-3.05mm (0.053-0.120")	1.35-2.62mm (0.053-0.103")
20	16-22AWG (1.5-0.35mm²)	1.02-2.41mm (0.040-.095")	-	1.02-02.41mm (0.040-0.095")	1.02-2.10mm (0.040-0.083")

DuraMate™ AHDM - Backshell Options and Accessory Overview



DuraMate™ AHDM - Plug & Receptacle Options (Dimensions in mm)

Shell Size 18 Plug (Zinc Alloy)		Shell Size 18 Receptacle (Zinc Alloy)		Shell Size 24 Plug (Zinc Alloy)		Shell Size 24 Receptacle (Zinc Alloy)	
Circular Bayonet, Integrated Wide Thread		Circular Bayonet, Integrated Wide Thread		Circular Bayonet, Integrated Wide Thread		Circular Bayonet, Integrated Wide Thread	
-	-	-	-	Shell Size 24 Plug (Aluminum Alloy)	Shell Size 24 Receptacle (Aluminum Alloy)	Shell Size 24 Plug (Aluminum Alloy)	Shell Size 24 Receptacle (Aluminum Alloy)
-	-	-	-	Blind Mate, Integrated Wide Thread (-B119)	Blind Mate, Integrated Wide Thread (-B119)	Blind Mate, Integrated Wide Thread (-B119)	Blind Mate, Integrated Wide Thread (-B119)
-	-	-	-				
-	-	-	-	Shell Size 24 Plug (Aluminum Alloy)	Shell Size 24 Receptacle (Aluminum Alloy)	Shell Size 24 Plug (Aluminum Alloy)	Shell Size 24 Receptacle (Aluminum Alloy)
-	-	-	-	Blind Mate (-B019)	Blind Mate (-B019)	Blind Mate (-B019)	Blind Mate (-B019)
-	-	-	-				

DuraMate™ AHDM - Backshell Options and Accessories

Note: Refer to individual datasheets on [www.amphenol-sine.com](http://www.amphenol-sine.com) for full specs, faceviews, keying location and product dimensions.

Image	Part Number	Description
	AHDMS-18-002	Shell Size 18, Backshell, 2PC, Compression Nut, DuraMate™ AHDM, Silver Body Note: Cable Size Range: 14.5 ~ 18.0
	AHDMS-18-001	Shell Size 18, Backshell, Tie Wrap, DuraMate™ AHDM, Black Body
	AHDMS-18-059	Shell Size 18, Backshell, w Cable Clamp, DuraMate™ AHDM, Silver Body Note: Cable Size Range: 11.20 ~ 19.30. Can be used with or without bushing
	AHDMS-18-SM01	Shell Size 18, Backshell, Silicone Rubber Ring, Clamp/Nut, DuraMate™ AHDM, Silver Body Note: For use with AHDM04/06-18-*P/S. Cable Size Range: 10.0 ~ 16.0.
	AHDMS-18-072	Shell Size 18, Backshell w Weep Holes, DuraMate™ AHDM, Silver Body Note: For use with AHDM04/06-18-*. Cable Size Range: 10.0 ~ 16.0.
	AHDMS-18-L005	Shell Size 18, Backshell w/out Weep Holes, DuraMate™ AHDM, Silver Body Note: For use with AHDM04/06-18-*. Cable Size Range: 10.0 ~ 16.0.
	AHDMS-24-002	Shell Size 24, Backshell, 2PC, Compression Nut, DuraMate™ AHDM, Silver Body Note: Cable Size Range: 14.5 ~ 18.0
	AHDMS-24-001	Shell Size 24, Backshell, Tie Wrap, DuraMate™ AHDM, Black Body
	AHDMS-24-059	Shell Size 24, Backshell, w Cable Clamp, DuraMate™ AHDM, Silver Body Note: Cable Size Range: 11.20 ~ 24.08. Can be used with bushings. (See datasheet)









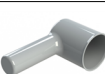













Image	Part Number	Description
	AHDMBS-24-SM01	Shell Size 24, Backshell, Silicone Rubber Ring, Clamp/Nut, DuraMate™ AHDM, Silver Body Note: For use with AHDM04/06-24-*. Cable Size Range: 12.0 ~ 18.0.
	AHDMBS-24-072	Shell Size 24, Backshell w Weep Holes, DuraMate™ AHDM, Silver Body Note: For use with AHDM04/06-24-*. Cable Size Range: 12.0 ~ 18.0.
	AHDPM18-BT	Shell Size 18, Boot, DuraMate™ AHDP (SRA only) & DuraMate™ AHDM, Grey Body
	AHDPM18-BT-BK	Shell Size 18, Boot, DuraMate™ AHDP (SRA only) & DuraMate™ AHDM, Black Body
	AHDPM18-BT-RA	Shell Size 18, Right Angle Boot, DuraMate™ AHDP (SRA only) & DuraMate™ AHDM, Grey Body
	AHDPM18-BT-RA-BK	Shell Size 18, Right Angle Boot, DuraMate™ AHDP (SRA only) & DuraMate™ AHDM, Black Body
	AHDPM24-BT	Shell Size 24, Boot, DuraMate™ AHDP (SRA only) & DuraMate™ AHDM, Grey Body
	AHDPM24-BT-BK	Shell Size 24, Boot, DuraMate™ AHDP (SRA only) & DuraMate™ AHDM, Black Body
	AHDPM24-BT-RA	Shell Size 24, Right Angle Boot, DuraMate™ AHDP (SRA only) & DuraMate™ AHDM, Grey Body
	AHDPM24-BT-RA-BK	Shell Size 24, Right Angle Boot, DuraMate™ AHDP (SRA only) & DuraMate™ AHDM, Black Body
	AHDM-BS-18NUT	Shell Size 18, Adapter for use with: - AHDPBS-015-1805 AHDP Backshell, Conduit, Snap-Over, Straight - AHDPBS-016-1805 AHDP Backshell, Conduit, Snap-Over, Right Angle
	AHDM-BS-24NUT	Shell Size 24, Adapter for use with: - AHDPBS-010-2405 AHDP Backshell, Conduit, Snap-Over, Straight - AHDPBS-011-2405 AHDP Backshell, Conduit, Snap-Over, Right Angle
	AHDC34-24	Shell Size 24, Protective Cap for Plug, DuraMate™ AHDM, Silver Body
	AHDC34-18	Shell Size 18, Protective Cap for Plug, DuraMate™ AHDM, Silver Body
	AHDC36-24	Shell Size 24, Protective Cap for Receptacle, DuraMate™ AHDM, Silver Body
	AHDC36-18	Shell Size 18, Protective Cap for Receptacle, DuraMate™ AHDM, Silver Body
	A112264	Shell Size 24, Lockwasher, DuraMate™ AHDM, Silver Body
	A114021	Shell Size 18, Lockwasher, DuraMate™ AHDM, Silver Body
	A112263-90	Shell Size 24, Nut, DuraMate™ AHDM, Silver Body
	A114020-90	Shell Size 18, Nut, DuraMate™ AHDM, Silver Body

Image	Part Number	Description
	CP-M1098-24	Shell Size 24, Snap Ring for Shaft Size Ø38.1mm, DuraMate™ AHDM, Metal, Silver Body
	CP-M1099-24	Shell Size 24, Snap Ring for Shaft Size Ø44.45mm, DuraMate™ AHDM, Metal, Silver Body
	AHDP-16-04477	Shell Size 24, Rubber Flange Seal, DuraMate™ AHDP and DuraMate™ AHDM, Black Body
	AHDP-16-04978	Shell Size 18, Rubber Flange Seal, DuraMate™ AHDP and DuraMate™ AHDM, Black Body
	A114019	Contact Size 4, Blank Seal Plug, Red Body
	A114018	Contact Size 8, Blank Seal Plug, White Body
	A114017	Contact Size 12/16, Blank Seal Plug, White Body
	AT13-217-1605	Contact Size 16, Locking Seal Plug, White Body
	AT13-204-2005	Contact Size 20, Blank Seal Plug, White Body
	AT11-027-0405	Contact Size 4+, Contact Removal Tool, 4AWG, Black Body
	AT114009	Contact Size 4, Contact Removal Tool, 6AWG, White Body
	AT11-001-3.6M	Contact Size 8, Contact Removal Tool, 7-10AWG, Black Body
	AT114008	Contact Size 8, Contact Removal Tool, 8-10AWG, Green Body
	AT11-337-1205	Contact Size 12, Contact Removal Tool, 12-14AWG, Orange Body
	AT11-310-1605	Contact Size 16, Contact Removal Tool, 16-20AWG, Turquoise Body
	AT11-240-2005	Contact Size 20, Contact Removal Tool, 20-22AWG, Red Body



# DM DuraMate™ AHDM/AHDBM ISOBUS 91 Series

## Environmentally-Sealed, Multi-Pin, Heavy-Duty, Metal Circular ISOBUS Connectors

Available in Shell Size 24, 9 Position

Amphenol Sine Systems' **DuraMate™ AHDM/AHDBM ISOBUS 91 Series** connectors are an environmentally-sealed, multi-pin, heavy duty, metal, circular connector with IP68 and IP69K ratings (in mated condition) that contains either a circular bayonet locking system or blind mate option, manufactured to withstand the challenges and complexities of harsh environment, off-road applications. **The DuraMate™ AHDM/AHDBM ISOBUS 91 Series is specifically designed to meet ISO 11783 standards (for control and communications between tractors, implements and software) and withstand the challenges and complexities of harsh environment, off-road, agricultural applications.**

### Important

- AHDBM 91 Series Plugs are intermateable to other industry standard versions and allow full breakaway functionality if used with suitable breakaway-ready Receptacles (like AHDBM 91 Receptacles)
- AHDM 91 Series Plugs are intermateable to other industry standard versions but do not retain breakaway functionality
- AHDBM 91 Series Receptacles (Circular Bayonet) are intermateable to other industry standard plugs and allow breakaway functionality when used with a breakaway Plugs (like AHDBM 91 Plugs)
- Available upon request and not shown on this flyer: AHDM 91 Series Receptacles (Drop Shaped Bayonet) are not intermateable to all industry standard versions and do not retain breakaway functionality

### Key ISOBUS 91 Series Features

- + One-to-one alternative for all HD30/HDB36 parts
- + Compatible to other industry standard (Circular Bayonet) versions while retaining full breakaway functionality
- + AHDM 91 Series Plugs have a jumper (bridged contacts) between Pin 4 & 5
- + AHDM/AHDBM 91 Series Receptacles don't have a jumper (bridged contact)
- + Options for up to 16mm<sup>2</sup> power wires
- + Full range of backshell options

### DuraMate™ Features

- 3 key-way circular bayonet design, or blind mate option, ensures proper mating of connectors
- High density signal and mixed power insert configurations
- Operating temperature range: -55°C to +125°C
- High-strength, impact resistant & lightweight zinc-alloy or aluminum alloy metal housings
- Low-insertion force stamped terminals offer improved manufacturing efficiencies
- Environmentally-sealed and engineered rapid and secure mating system achieves up to IP69K rating (in mated condition) from ingress of dust, water, mud and other contaminants and is vibration resistant
- Sealing features consisting of durable high-temperature silicone provide barrier from lubricating oils, hydraulic fluids and fossil fuels
- Backshells maintain a compression-fit design to resist maximum pull-out forces and facilitate strain-relief for jacketed cable ranges
- Wire entry sealing available in four separate ranges for discrete wire applications
- Integrated Wide Threading provides an enhanced threading for use with our wide variety of screw-on or clamshell backshells
- Utilizes A Series™ standard contact system (Stamped & Formed or Machined)

### IP Ratings

IP67 rated (Dust tight; 1M of Water for 30 Minutes, in mated condition)  
 IP68 rated (Dust tight; 1M of Water for 24 Hours, in mated condition)  
 IP69K rated (Dust tight; High-Pressure Waterproof, 4 Points (0°, 30°, 60°, 90°), in mated condition)







Standard products. Custom solutions  
 Customer Service +1 800 394 7732

DuraMate™ AHDM/AHDBM ISOBUS 91 Series - Specifications (Reference Individual Datasheets)

IP Rating (in mated condition)	IP68 and IP69K
Max. Current (Amperage)	Size 8, 60A; Size 12, 25A; Size 16, 13A
Max. Voltage Rating	250V
Operating Temperature	-55°C to +125°C
Coupling System	Circular Bayonet or Blind Mate
Housing Body	Zinc Alloy or Aluminum Alloy
Insulation Insert	Thermoplastic UL94-VO
Contact Types	Stamped & Formed, Machined
Contact Material	Copper Alloy

Sealing Material	Silicone Rubber
Min. Mating Cycles	>100
Flammability Rating	UL94-VO
Fluid Resistance	Gas, oil, mineral oil, acid bath, basic bath
RoHS Compliant	ALL materials meet the requirements of the European Directive. (See website for documentation)

DuraMate™ AHDM/AHDBM ISOBUS 91 Series - Insert Arrangements

<b>Size 24</b> 24-91 2 x Size 8, 2 x Size 12, 5 x Size 16 (N) (R)	Contact Legend (Size/Amp)			
				
	Size 8 (6AWG) 60A	Size 8 (8-10AWG) 60A	Size 12 25A	Size 16 13A

DuraMate™ AHDM/AHDBM ISOBUS 91 Series - Recommended Wire Insulation Overall Diameter (OD)

Contact Size	Typical Wire Range	(N) Normal Seal	(R) Reduced Seal	(R) Reduced Seal for 6AWG/16mm <sup>2</sup> (Size 8 Contacts Only)
8	6-10AWG (5.0-16.0mm <sup>2</sup> )	4.83-6.10mm (0.190-0.240")	3.43-5.59mm (0.135-0.220")	6.50-7.42mm (0.256-0.292")
12	10-14AWG (6.0-2.0mm <sup>2</sup> )	3.40-4.32mm (0.134-0.170")	2.46-4.01mm (0.135-0.158")	2.46-4.01mm (0.135-0.158")
16	14-20AWG (2.0-0.5mm <sup>2</sup> )	2.54-3.40mm (0.100-0.134")	1.35-3.05mm (0.053-0.120")	1.35-3.05mm (0.053-0.120")

DuraMate™ AHDM/AHDBM ISOBUS 91 Series - Backshell Options and Accessory Overview



DuraMate™ AHDM/AHDBM ISOBUS 91 Series - Plug & Receptacle Options (Dimensions in mm)

Shell Size 24 AHDM Plug (Zinc Alloy)		Shell Size 24 AHDBM Breakaway Plug (Zinc Alloy)		Shell Size 24 AHDBM Breakaway Receptacle (Zinc Alloy)	
Circular Bayonet, Integrated Wide Thread		Circular Bayonet, Integrated Wide Thread		Circular Bayonet, Integrated Wide Thread	
Shell Size 24 AHDM Plug (Aluminum Alloy)				Shell Size 24 AHDM Receptacle (Aluminum Alloy)	
Blind Mate		-		Blind Mate	
		-			
Shell Size 24 AHDM Extended Shell Plug (Aluminum Alloy)				Shell Size 24 AHDM Extended Shell Receptacle (Aluminum Alloy)	
Blind Mate		-		Blind Mate	
		-			



DuraMate™ AHDM ISOBUS 91 Series - Circular Bayonet Plugs (Zinc Alloy)

Note: Refer to individual datasheets on [www.amphenol-sine.com](http://www.amphenol-sine.com) for full specs, faceviews, keying location and product dimensions.

Image	Part Number	Description	Contact Size/Amp	Voltage
	AHDM06-24-91SN	Shell Size 24, 9 Position, Plug, Socket, DuraMate™ AHDM ISOBUS 91 Series, Metal, Normal Diameter Seal (Green), Integrated Wide Threading	Size 8, 60A Size 12, 25A Size 16, 13A	250V
	AHDM06-24-91SN-059	Shell Size 24, 9 Position, Kit, Plug, Socket, DuraMate™ AHDM ISOBUS 91 Series, Metal, Normal Diameter Seal (Green), Integrated Wide Threading, Cable Clamp Backshell	Size 8, 60A Size 12, 25A Size 16, 13A	250V
	AHDM06-24-91SR	Shell Size 24, 9 Position, Plug, Socket, DuraMate™ AHDM ISOBUS 91 Series, Metal, Reduced Diameter Seal (Blue), Integrated Wide Threading	Size 8, 60A Size 12, 25A Size 16, 13A	250V
	AHDM06-24-91SR-059	Shell Size 24, 9 Position, Kit, Plug, Socket, DuraMate™ AHDM ISOBUS 91 Series, Metal, Reduced Diameter Seal (Blue), Integrated Wide Threading, Cable Clamp Backshell	Size 8, 60A Size 12, 25A Size 16, 13A	250V
	AHDM06-24-91SR16	Shell Size 24, 9 Position, Plug, Socket, DuraMate™ AHDM ISOBUS 91 Series, Metal, Reduced Diameter Seal (Blue), Integrated Wide Threading, Size 8 Contact, 6AWG/16mm <sup>2</sup> Wire Seal Note: Use AT62-203-08141-16 contacts for 6AWG/16mm <sup>2</sup> applications	Size 8, 60A Size 12, 25A Size 16, 13A	250V
	AHDM06-24-91SR16-059	Shell Size 24, 9 Position, Kit, Plug, Socket, DuraMate™ AHDM ISOBUS 91 Series, Metal, Reduced Diameter Seal (Blue), Integrated Wide Threading, Cable Clamp Backshell, Size 8 Contact, 6AWG/16mm <sup>2</sup> Wire Seal Note: Use AT62-203-08141-16 contacts for 6AWG/16mm <sup>2</sup> applications	Size 8, 60A Size 12, 25A Size 16, 13A	250V

DuraMate™ AHDBM ISOBUS 91 Series - Blind Mate Plugs (Aluminum Alloy)

Note: Refer to individual datasheets on [www.amphenol-sine.com](http://www.amphenol-sine.com) for full specs, faceviews, keying location and product dimensions.

Image	Part Number	Description	Contact Size/Amp	Voltage
	AHDM08-24-91SR16-B019	Shell Size 24, 9 Position, Plug, Socket, Size 8/12/16 Contacts, 60A/25A/13A, 250V, DuraMate™ AHDM ISOBUS 91 Series, Aluminum Alloy, Blind Mate Coupling System, Reduced Diameter Rear Seal (Red), Blue Retaining Ring, Keyed, Silver Body	Size 8, 60A Size 12, 25A Size 16, 13A	250V
	AHDM08-24-91SR-B019	Shell Size 24, 9 Position, Plug, Socket, Size 8/12/16 Contacts, 60A/25A/13A, 250V, DuraMate™ AHDM ISOBUS 91 Series, Aluminum Alloy, Blind Mate Coupling System, Reduced Diameter Rear Seal (Red), Blue Retaining Ring, Keyed, Silver Body	Size 8, 60A Size 12, 25A Size 16, 13A	250V
	AHDM08-24-91SR-ETS	Shell Size 24, 9 Position, Extended Shell Plug, Socket, Size 8/12/16 Contacts, 60A/25A/13A, 250V, DuraMate™ AHDM ISOBUS 91 Series, Aluminum Alloy, Blind Mate Coupling System, Reduced Diameter Rear Seal (Red), Blue Retaining Ring, Keyed, Silver Body	Size 8, 60A Size 12, 25A Size 16, 13A	250V



DuraMate™ AHDBM ISOBUS 91 Series - Circular Bayonet, Breakaway-Ready Plugs (Zinc Alloy)

Note: Refer to individual datasheets on [www.amphenol-sine.com](http://www.amphenol-sine.com) for full specs, faceviews, keying location and product dimensions.

Image	Part Number	Description	Contact Size/Amp	Voltage
	AHDBM06-24-91SN	Shell Size 24, 9 Position, Plug, Socket, Shell DuraMate™ AHDBM ISOBUS 91 Series, Metal, Normal Diameter Seal (Green), Integrated Wide Threading, Breakaway-Ready	Size 8, 60A Size 12, 25A Size 16, 13A	250V
	AHDBM06-24-91SN-059	Shell Size 24, 9 Position, Kit, Plug, Socket, Shell DuraMate™ AHDBM ISOBUS 91 Series, Metal, Normal Diameter Seal (Green), Integrated Wide Threading, Cable Clamp Backshell, Breakaway-Ready	Size 8, 60A Size 12, 25A Size 16, 13A	250V
	AHDBM06-24-91SR	Shell Size 24, 9 Position, Plug, Socket, Shell DuraMate™ AHDBM ISOBUS 91 Series, Metal, Reduced Diameter Seal (Blue), Integrated Wide Threading, Breakaway-Ready	Size 8, 60A Size 12, 25A Size 16, 13A	250V
	AHDBM06-24-91SR-059	Shell Size 24, 9 Position, Kit, Plug, Socket, DuraMate™ AHDBM ISOBUS 91 Series, Metal, Reduced Diameter Seal (Blue), Integrated Wide Threading, Cable Clamp Backshell, Breakaway-Ready	Size 8, 60A Size 12, 25A Size 16, 13A	250V
	AHDBM06-24-91SR16	Shell Size 24, 9 Position, Kit, Plug, Socket, DuraMate™ AHDBM ISOBUS 91 Series, Metal, Reduced Diameter Seal (Blue), Integrated Wide Threading, Cable Clamp Backshell, Breakaway, Size 8 Contact, 6AWG/16mm² Wire Seal Note: Use AT62-203-08141-16 contacts for 6AWG/16mm² applications	Size 8, 60A Size 12, 25A Size 16, 13A	250V
	AHDBM06-24-91SR16-059	Shell Size 24, 9 Position, Plug, Socket, DuraMate™ AHDBM ISOBUS 91 Series, Metal, Reduced Diameter Seal (Blue), Integrated Wide Threading, Breakaway, Size 8 Contact, 6AWG/16mm² Wire Seal Note: Use AT62-203-08141-16 contacts for 6AWG/16mm² applications	Size 8, 60A Size 12, 25A Size 16, 13A	250V

DuraMate™ AHDM ISOBUS 91 Series - Blind Mate Receptacles (Aluminum Alloy)

Note: Refer to individual datasheets on [www.amphenol-sine.com](http://www.amphenol-sine.com) for full specs, faceviews, keying location and product dimensions.

Image	Part Number	Description	Contact Size/Amp	Voltage
	AHDM09-24-91PR16-B019	Shell Size 24, 9 Position, Receptacle, Pin, Size 8/12/16 Contacts, 60A/25A/13A, 250V, DuraMate™ AHDM ISOBUS 91 Series, Aluminum Alloy, Blind Mate Coupling System, Reduced Diameter Rear Seal (Red) for Size 12/16 Contacts, Blue Retaining Ring, Keyed, Silver Body	Size 8, 60A Size 12, 25A Size 16, 13A	250V
	AHDM09-24-91PR-B019	Shell Size 24, 9 Position, Receptacle, Pin, Size 8/12/16 Contacts, 60A/25A/13A, 250V, DuraMate™ AHDM ISOBUS 91 Series, Aluminum Alloy, Blind Mate Coupling System, Reduced Diameter Rear Seal (Red) for Size 12/16 Contacts, Blue Retaining Ring, Keyed, Silver Body	Size 8, 60A Size 12, 25A Size 16, 13A	250V
	AHDM09-24-91PR-ETS	Shell Size 24, 9 Position, Extended Shell Receptacle, Pin, Size 8/12/16 Contacts, 60A/25A/13A, 250V, DuraMate™ AHDM ISOBUS 91 Series, Aluminum Alloy, Blind Mate Coupling System, Reduced Diameter Rear Seal (Red) for Size 12/16 Contacts, Blue Retaining Ring, Keyed, Silver Body	Size 8, 60A Size 12, 25A Size 16, 13A	250V

DuraMate™ AHDBM ISOBUS 91 Series - Circular Bayonet, Breakaway-Ready Receptacles (Zinc Alloy)

Image	Part Number	Description	Contact Size/Amp	Voltage
	AHDBM04-24-91PN	Shell Size 24, 9 Position, Breakaway-Ready Receptacle, Pin, DuraMate™ AHDBM ISOBUS 91 Series, Metal, Normal Diameter Seal (Green), Integrated Wide Threading, Breakway-Ready	Size 8, 60A Size 12, 25A Size 16, 13A	250V
	AHDBM04-24-91PN-059	Shell Size 24, 9 Position, Kit, Breakaway-Ready Receptacle, Pin, DuraMate™ AHDBM ISOBUS 91 Series, Metal, Normal Diameter Seal (Green), Integrated Wide Threading, Cable Clamp Backshell, Breakway-Ready	Size 8, 60A Size 12, 25A Size 16, 13A	250V
	AHDBM04-24-91PR	Shell Size 24, 9 Position, Breakaway-Ready Receptacle, Pin, DuraMate™ AHDBM ISOBUS 91 Series, Metal, Reduced Diameter Seal (Blue), Integrated Wide Threading, Breakway-Ready	Size 8, 60A Size 12, 25A Size 16, 13A	250V
	AHDBM04-24-91PR-059	Shell Size 24, 9 Position, Kit, Breakaway-Ready Receptacle, Pin, DuraMate™ AHDBM ISOBUS 91 Series, Metal, Reduced Diameter Seal (Blue), Integrated Wide Threading, Cable Clamp Backshell, Breakway-Ready	Size 8, 60A Size 12, 25A Size 16, 13A	250V
	AHDBM04-24-91PR16	Shell Size 24, 9 Position, Breakaway-Ready Receptacle, Pin, DuraMate™ AHDBM ISOBUS 91 Series, Metal, Reduced Diameter Seal (Blue), Integrated Wide Threading, Breakway-Ready, Size 8 Contact, 6AWG/16mm² Wire Seal Note: Use AT60-204-08141-16 contacts for 6AWG/16mm² applications	Size 8, 60A Size 12, 25A Size 16, 13A	250V
	AHDBM04-24-91PR16-059	Shell Size 24, 9 Position, Kit, Breakaway-Ready Receptacle, Pin, DuraMate™ AHDBM ISOBUS 91 Series, Metal, Reduced Diameter Seal (Blue), Integrated Wide Threading, Cable Clamp Backshell, Breakway-Ready, Size 8 Contact, 6AWG/16mm² Wire Seal Note: Use AT60-204-08141-16 contacts for 6AWG/16mm² applications	Size 8, 60A Size 12, 25A Size 16, 13A	250V

DuraMate™ AHDM/AHDBM ISOBUS 91 Series - Backshell Options and Accessories

Note: Refer to individual datasheets on [www.amphenol-sine.com](http://www.amphenol-sine.com) for full specs, faceviews, keying location and product dimensions.



























Image	Part Number	Description
	AHDMB5-24-002	Shell Size 24, Backshell, 2PC, Compression Nut, DuraMate™ AHDM, Silver Body Note: Cable Size Range: 14.5 ~ 18.0
	AHDMB5-24-001	Shell Size 24, Backshell, Tie Wrap, DuraMate™ AHDM, Black Body
	AHDMB5-24-059	Shell Size 24, Backshell, w Cable Clamp, DuraMate™ AHDM, Silver Body Note: Cable Size Range: 11.20 ~ 24.08. Can be used with bushings. (See datasheet)
	AHDMB5-24-SM01	Shell Size 24, Backshell, Silicone Rubber Ring, Clamp/Nut, DuraMate™ AHDM, Silver Body Note: For use with AHDM04/06-24-*. Cable Size Range: 12.0 ~ 18.0.
	AHDMB5-24-072	Shell Size 24, Backshell w Weep Holes, DuraMate™ AHDM, Silver Body Note: For use with AHDM04/06-24-*. Cable Size Range: 12.0 ~ 18.0.
	AHDMB5-24-L005	Shell Size 24, Backshell w/out Weep Holes, DuraMate™ AHDM, Silver Body Note: For use with AHDM04/06-24-*. Cable Size Range: 12.0 ~ 18.0.
	AHDPM24-BT	Shell Size 24, Boot, DuraMate™ AHDP (SRA only) & DuraMate™ AHDM, Grey Body
	AHDPM24-BT-BK	Shell Size 24, Boot, DuraMate™ AHDP (SRA only) & DuraMate™ AHDM, Black Body

Image	Part Number	Description
	AHDP24-BT-RA	Shell Size 24, Right Angle Boot, DuraMate™ AHDP (SRA only) & DuraMate™ AHDM, Grey Body
	AHDP24-BT-RA-BK	Shell Size 24, Right Angle Boot, DuraMate™ AHDP (SRA only) & DuraMate™ AHDM, Black Body
	AHDM-BS-24NUT	Shell Size 24, Adapter for use with: AHDPBS-010-2405 AHDP Backshell, Conduit, Snap-Over, Straight AHDPBS-011-2405 AHDP Backshell, Conduit, Snap-Over, Right Angle
	AHDC34-24	Shell Size 24, Protective Cap for Plug, DuraMate™ AHDM, Silver Body
	AHDC36-24	Shell Size 24, Protective Cap for Receptacle, DuraMate™ AHDM, Silver Body
	A112264	Shell Size 24, Lockwasher, DuraMate™ AHDM, Silver Body
	A112263-90	Shell Size 24, Nut, DuraMate™ AHDM, Silver Body
	AHDP-16-04477	Shell Size 24, Rubber Flange Seal, DuraMate™ AHDP and DuraMate™ AHDM, Black Body
	CP-M1098-24	Shell Size 24, Snap Ring for Shaft Size Ø38.1mm, DuraMate™ AHDM, Metal, Silver Body
	CP-M1099-24	Shell Size 24, Snap Ring for Shaft Size Ø44.45mm, DuraMate™ AHDM, Metal, Silver Body
	A114017	Contact Size 12/16, Blank Seal Plug, White Body
	AT13-217-1605	Contact Size 16, Locking Seal Plug, White Body
	AT11-001-3.6M	Contact Size 8, Contact Removal Tool, 7-10AWG, Black Body
	AT114008	Contact Size 8, Contact Removal Tool, 8-10AWG, Green Body
	AT11-337-1205	Contact Size 12, Contact Removal Tool, 12-14AWG, Orange Body
	AT11-310-1605	Contact Size 16, Contact Removal Tool, 16-20AWG, Turquoise Body
	AT60-204-08141-16	Contact Size 8, 6AWG/16mm² Wire Range, Contact, Pin, Nickel-plated Note: Refer to Plug/Receptacle datasheets for a complete list of available contacts
	AT62-203-08141-16	Contact Size 8, 6AWG/16mm² Wire Range, Contact, Socket, Nickel-plated Note: Refer to Plug/Receptacle datasheets for a complete list of available contacts